

**DAIKIN**



REV	02
Date	09-2025
Supersedes	D-EOMOC01409-24_02EN

**Installation and Operating Manual  
D-EOMOC01409-24\_02EN**

**Cascade System (Opt. 237)**

**EWYT-B**

**EWWD(H)(S)-VZA / EWW(D)(H)(S)-J-**

# Table of contents

List of Figures.....	4
VERSIONING.....	5
1 WHAT IS CASCADE SYSTEM.....	6
1.1 Introduction.....	6
1.2 Acronyms.....	6
1.3 Applications.....	6
1.4 Cascade Architecture.....	6
1.4.1 Cable Connection and Specifications.....	8
1.5 Hardware architecture.....	9
1.5.1 Unit Options and Accessory Table.....	10
1.6 Compatibility List.....	10
2 LICENSING.....	11
2.1 When license is needed.....	11
2.2 Temporary License.....	11
2.3 Permanent License.....	12
3 HEATING ONLY APPLICATION.....	13
3.1 Plant layout.....	13
4 HMI DESCRIPTION.....	15
4.1 Introduction.....	15
4.2 Main Overview.....	15
4.3 Cascade Menu.....	15
4.3.1 Configuration menu.....	16
4.3.2 Data menu.....	16
4.3.3 Settings menu.....	19
4.3.4 Maintenance menu.....	19
5 SYSTEM COMMISSIONING.....	20
5.1 How to configure the Cascade.....	20
5.1.1 Software Options Menu.....	20
5.1.2 System Control Menu.....	20
5.1.3 Configuration Menu.....	21
5.2 How to configure Ethernet IP communication.....	21
5.2.1 IP settings for controllers.....	21
5.2.2 IP settings for BACnet IP Module (only Master) (EKCBACIP).....	21
5.3 How to configure BACnet IP for Cascade.....	22
5.3.1 BACnet IP Embedded.....	22
5.3.2 BACnet IP Module (only Master).....	23
5.4 How to setup Unit to communicate with Cascade.....	23
5.5 How to setup the Cascade.....	23
5.5.1 Staging Temperatures Settings.....	24
6 SYSTEM OPERATING.....	25
6.1 Cascade Enable setpoint.....	25
6.2 System actual operating mode setpoint.....	25
6.2.1 Mode Setpoints by Network communication.....	25
6.3 System water temperature setpoints.....	25
6.3.1 Cool Setpoint.....	25
6.3.2 Heat Setpoint.....	25
6.3.3 Domestic Hot Water Setpoint.....	25
6.3.4 System Setpoints by Network communication.....	25
7 BAS INTEGRATION GUIDE.....	26
7.1 BACnet Integration Guide.....	26
7.2 MODbus Integration Guide.....	27

8	TROUBLESHOOTING .....	29
8.1	BACnet Option Alarm .....	29
8.2	Cascade / WHCP / ACHP Missing Alarm .....	29
8.3	Cascade / WCHP / ACHP Communication Error Alarm.....	29
8.4	Domestic Hot Water Temperature Alarm.....	30
8.5	Evaporator Leaving Water Temperature Alarm .....	30

## List of Figures

---

Figure 1 - Architecture with AC unit as Cascade Master .....	7
Figure 2 - Architecture with WC unit as Cascade Master .....	7
Figure 3 - Cascade System in case of iCM Management .....	8
Figure 4 - Cable Connections.....	8
Figure 5 - AC iCM System and WC iCM System in DHW Cascade management .....	9
Figure 6: Temporary Activation .....	11
Figure 7: Temporary password activation .....	11
Figure 8: Software Options page.....	12
Figure 9: Enter the license code.....	12
Figure 10: Activate the iCM Standard .....	12
Figure 11 Only Heating plant.....	13
Figure 12 Cascade Configuration 1 to 1.....	13
Figure 13: Main overview page .....	15
Figure 14: Cascade address setting.....	20
Figure 15: Cascade configuration menu .....	21
Figure 16: Plant Type setting .....	21
Figure 17: BACnet IP menu .....	22
Figure 18: BACnet IP module configuration .....	23
Figure 19: Settings menu in Mixed Operation configuration.....	23
Figure 20: DHW production settings .....	24

# 1 VERSIONING

---

Revision	Software Version	Changelog
0 – 09/2024	Cascade_1.01	Introduction of Cascade
1 – 04/2025	Cascade_1.03	Only Heating System

## 2 WHAT IS CASCADE SYSTEM

### 2.1 Introduction

This document describes the functionality and logic behind a Cascade System represented by a combination of two Daikin units, one Air-cooled heat pump and one water cooled heat pump, able to manage and satisfy load request for Comfort Heating, Domestic Hot Water and Comfort Cooling systems.

### 2.2 Acronyms

This document uses acronyms to refer to specific units and water systems.

Acronym	Device	Description
ACHP	Air cooled heat pump	Unit able to perform operation mode changeover and to produce Cold Water or Hot Water
WCHP	Water cooled heat pump	Unit provided of two exchangers: one of the two exchanger is able to produce high temperature hot water
DHW	Domestic Hot Water	Water distribution system for daily hot water use (showers, taps, etc)
HWD	Comfort Hot water distribution	Water distribution system and peripherals for hot water (radiators, fan coils, underfloor radiant panels)
CWD	Comfort Cooling water Distribution	Water distribution system and peripherals for cold water (fan coils, ceiling or underfloor radiant panels)
Hot Tank	Hot Tank	Tank where municipal water is heated by WCHP and distributed through DHW system
BACnet	BACnet/IP Network	
DCN	Daikin Communication Network	P2P connection based on process bus of Microtech controllers allowing data exchange among the units.
Elwt	Evaporator Leaving water temperature	Evaporator Leaving water temperature of WCHP
Eewt	Evaporator Entering water temperature	Evaporator Entering water temperature of WCHP
Clwt	Condenser Leaving water temperature	Condenser Leaving water temperature of WCHP
Cewt	Condenser Entering water temperature	Condenser Entering water temperature of WCHP
THwt	Tank Hot water temperature	
SysHStp	System Hot Setpoint	Hot temperature setpoint of Cascade Control
SysCStp	System Cool Setpoint	Cool temperature setpoint of Cascade Control
DHWStp	Domestic hot water setpoint	Hot temperature setpoint of DHW system

**Table 1 - Acronyms**

### 2.3 Applications

Cascade system have two different applications and consequently can be applied to two different water distribution systems:

**Heating Only** for:

- a) Domestic Hot Water production
- b) Heating production

In both configuration WCHP generates the heat capacity necessary to satisfy HWD demand or DHW demand.

This configuration parameter makes available specific settings for each application.

### 2.4 Cascade Architecture

First requirement is the possibility to have a unique interface to interact with Cascade Management and to change the main setpoints:

- Cascade Enable Command (On/Off),
- Temperature setpoints for DHW, CWD and HWD
- Operation mode setpoint

Thus, the system architecture is as follow:

- 1) One unit is elected as Cascade Master; consequently, the logic of Cascade management is running on this unit.
- 2) The second unit is elected as Cascade Slave; consequently, it is commanded by Cascade Master through communication.

- 3) Communication between Cascade Master and Slave is BACnet/IP. For this reason, the network architecture must be as follow:
- Each unit controller must have Software Option: BACnet/IP configured: OPTION 182.
  - Unit elected as Cascade Master must have BACnet/IP Module (POL908): EKCBACIP.
  - Industrial Ethernet Switch to connect BACnet IP Module and the two controllers in a BACnet Network

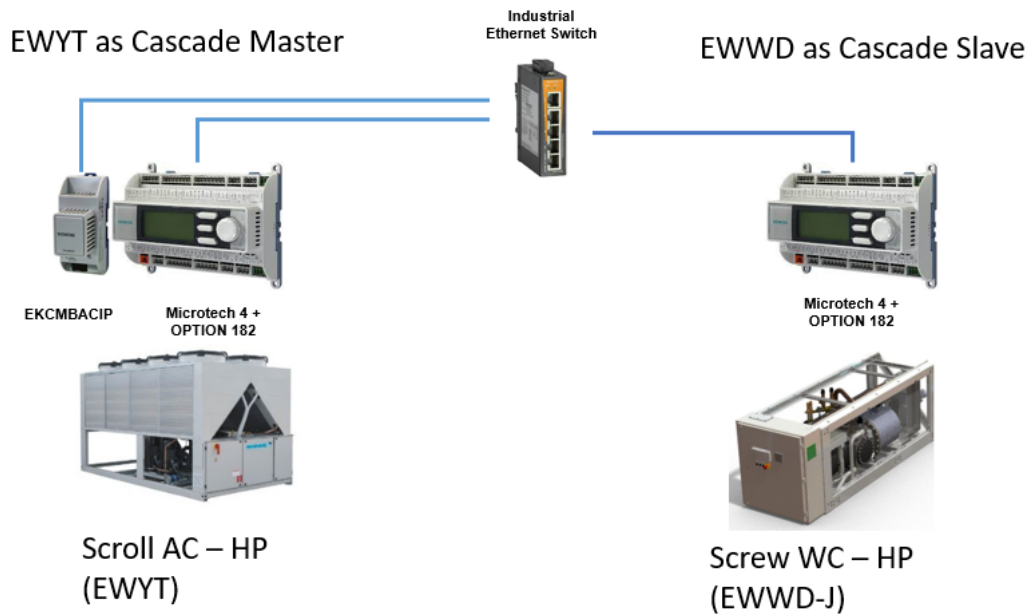

**Figure 1 - Architecture with AC unit as Cascade Master**

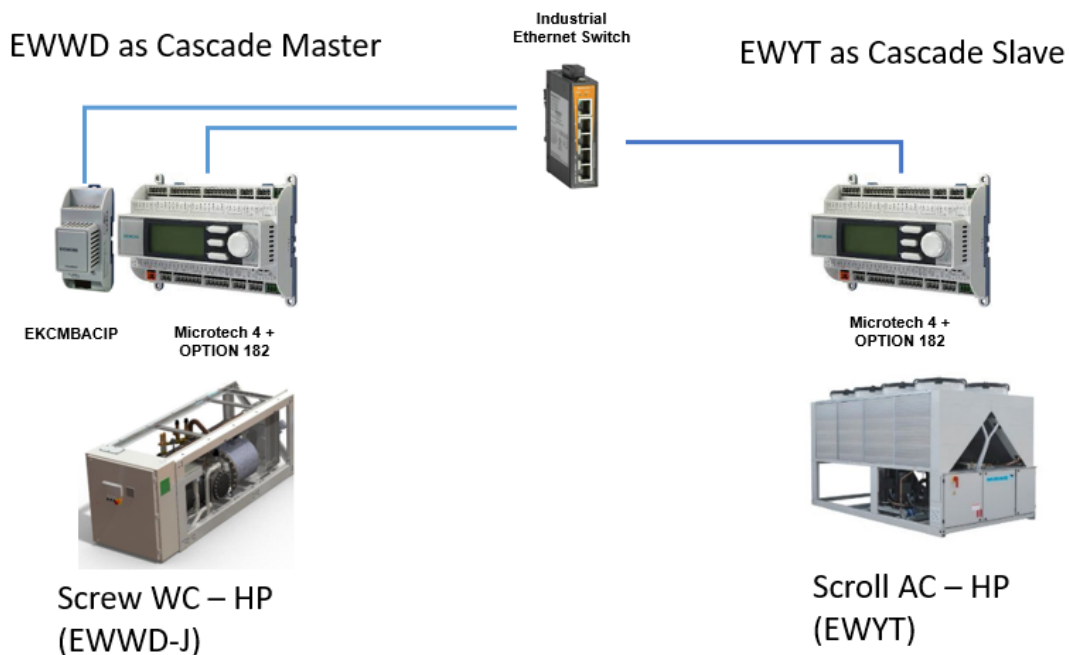

**Figure 2 - Architecture with WC unit as Cascade Master**

- 4) Cascade Management is compatible with iCM Management. It is possible to have two iCM systems (one grouping N number of AC-HP units and one consisting in M number of WC HP units) that work together in cascade mode.
- One of the two iCM Master units must be elected as Cascade Master
  - The other iCM Master must be configured as Cascade Slave

Consequently, the controller architecture is shown in the following picture:

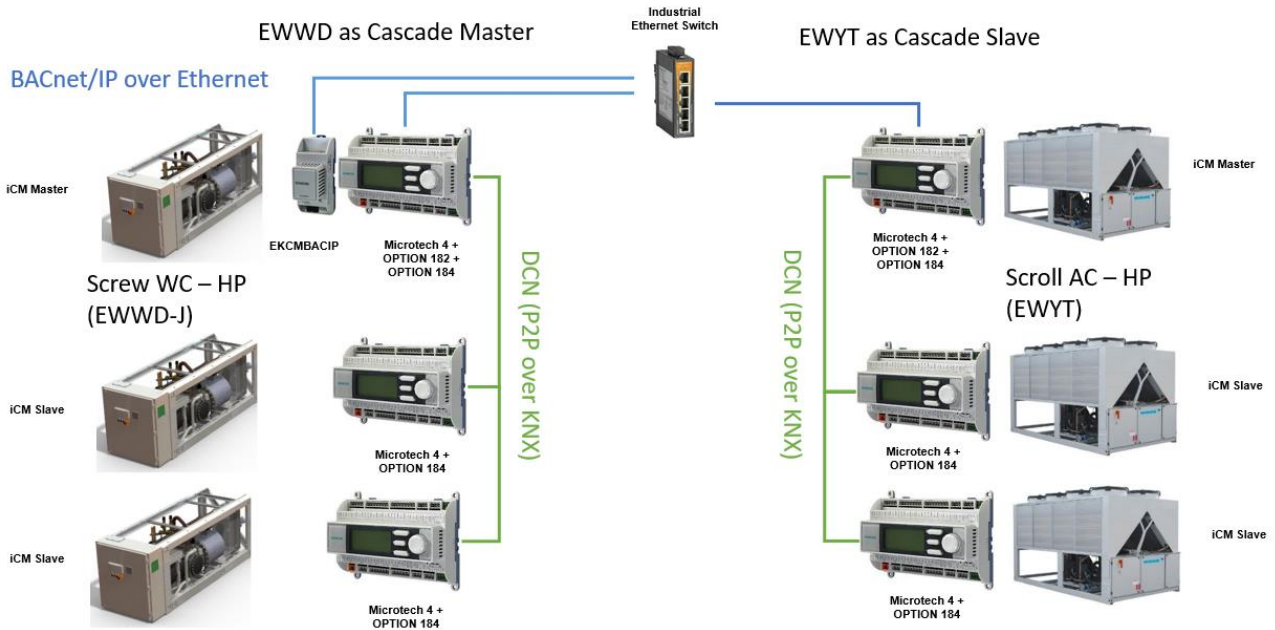

Figure 3 - Cascade System in case of iCM Management

### 2.4.1 Cable Connection and Specifications

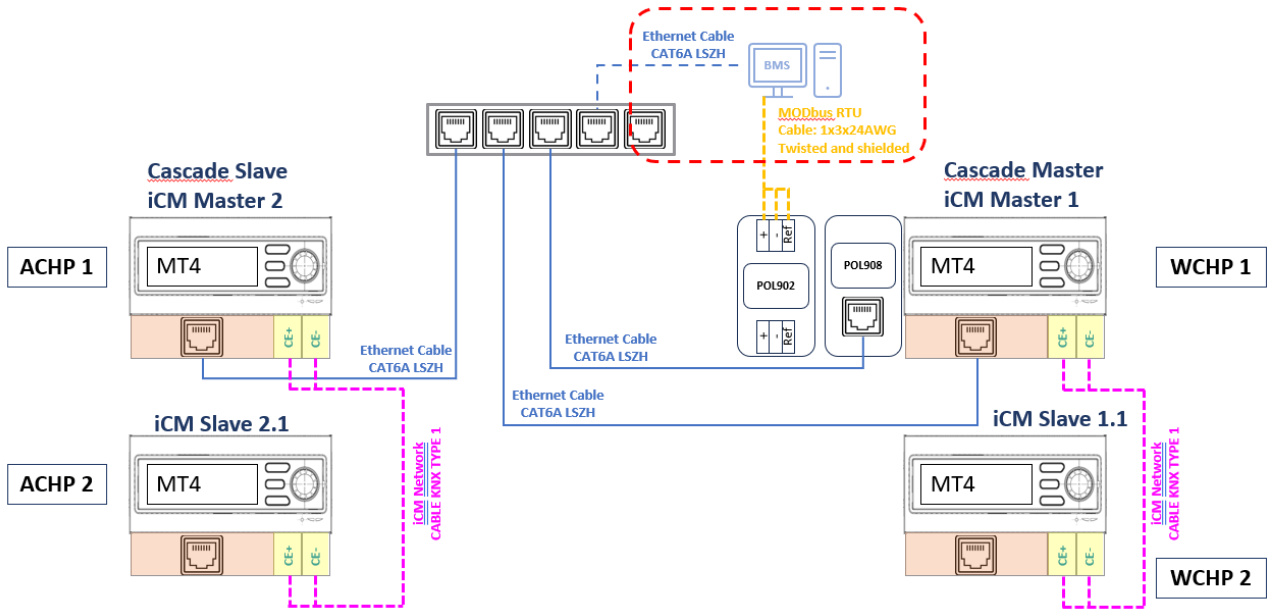

Figure 4 - Cable Connections

The cable must comply with the following specification:

- Ethernet cable:
  - o CAT6A LSZH
  - o Max 150m
- Konnex Cable:
  - o KNX certified
  - o 1 x 2 x 24AWG
  - o Max 1 km
- MODbus RTU cable:
  - o Twisted Shielded
  - o 1 x 3 x 24AWG
  - o Max 1 km



## 2.5 Hardware architecture

According to type of cascade plant, some additional hardware is mandatory:  
 In case of Only Heating or DHW system:

- A. DHW or HWD LWT sensor to be installed in Hot water Tank or Hot water supply header and connected to WC-HP controller as Common Heat LWT sensor input (same as in case of iCM option). Type: NTC10K (EKTSMS).

In case of Cascade System and iCM systems, additional sensors of iCM are mandatory:  
 In case of Only Heating or DHW system:

- A. DHW or HWD sensor to be installed in Hot water Tank or Hot water supply header and connected to iCM Master WC-HP controller as Common Heat LWT sensor input. Type: NTC10K (EKTSMS).
- B. Common Cool LWT sensor to be installed in Common evaporator supply header and connected to iCM Master WC-HP controller as Common Cool LWT sensor. Type: NTC10K (EKTSMS).
- C. Common LWT sensor to be installed in Common evaporator supply header and connected to iCM Master AC-HP controller as Common LWT sensor. Type: NTC10K (EKTSMS).

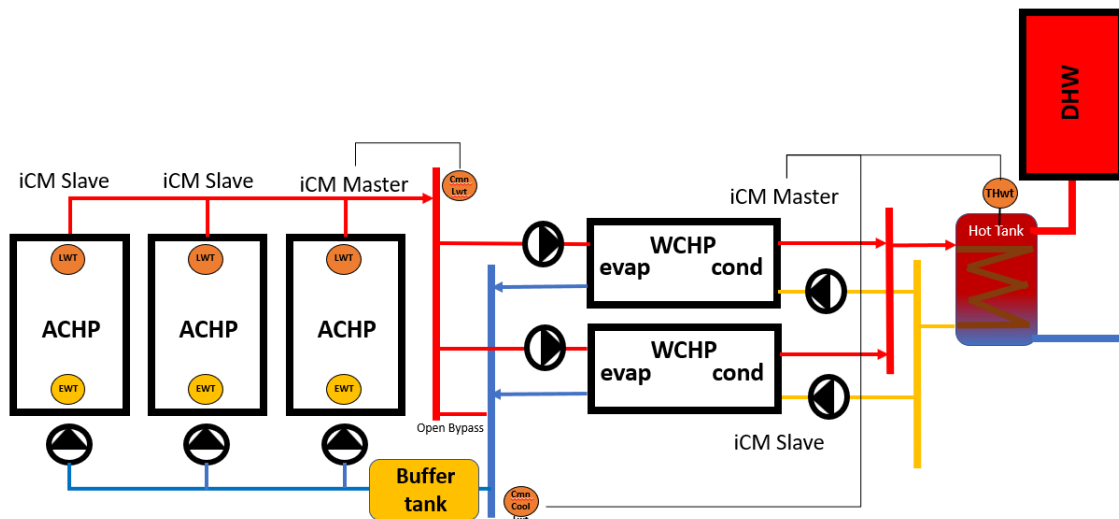

Figure 5 - AC iCM System and WC iCM System in DHW Cascade management

## 2.5.1 Unit Options and Accessory Table

According to the type of plant-room to be managed by Cascade function, certain option on the two controllers are necessary, as resumed in the below table:

1 to 1 Units	Only DHW plant
Air Cooled unit	Option 237 (Cascade) Option 182 (BACnet/IP)
Water Cooled unit	Option 237 (Cascade) Option 182 (BACnet/IP) EKTSMS (Common Heat Lwt) EKCBACIP (BACnet /IP module)
Additional hardware	Industrial Ethernet Switch

N to M Units	Only DHW plant
Air Cooled unit	Option 237 (Cascade) Only for iCM Master Option 182 (BACnet/IP) Option 184 (iCM Standard) EKTSMS (Common Lwt)
Water Cooled unit	Option 237 (Cascade) Only for iCM Master Option 182 (BACnet/IP) Option 184 (iCM Standard) EKTSMS (Common Heat Lwt) 2x EKTSMS (Common Cool Lwt) EKCBACIP (BACnet /IP module)
Additional hardware	Industrial Ethernet Switch

## 2.6 Compatibility List

Cascade is compatible with:

- 2-pipe plant-room, in the following alternative layouts:
  - a. Domestic Hot Water Only production managed by WC-HP  
OR
  - b. Comfort Cool/Heat + DHW Production: 2-pipe Cool/Heat Primary circuit managed by AC-HP + DHW circuit dedicated to WC-HP.  
NOTE: the AC-HP and WC-HP cannot alternate in the Comfort Heating production. WC-HP is dedicated exclusively to DHW production.
- plant-room layouts composed by following units:
  - Air cooled Scroll heat pump: EWYT-B
  - Water cooled Screw heat pump: EWW\*-J;
- Option 184 (ICM Standard), with restrictions on some iCM functions.
- Option 155 (Router Daikin On Site) with restrictions;
- Option ---- (Daikin App) with restrictions;

NOTE: Daikin on Site router or Daikin App access point must be connected to industrial ethernet switch.

Cascade is not compatible with:

- 4 pipe plant-room
- Only Chiller units
- Multipurpose units
- iCM Functions:
  - Master/Slave
  - Sensorless configuration (Common LWT sensors are mandatory)
  - iCM Expandable
  - BackToBack (EWYT-B)
- Unit Software Options:
  - Rapid Restart
  - Heat Recovery
- General Option:
  - Daikin on Site for both units
  - Daikin App for both units

NOTE: Daikin on site and Daikin app are available only for unit configured with default static IP Address 192.168.1.42

### 3 LICENSING

#### 3.1 When license is needed

When the plant configuration requires Cascade option a License key is needed. The License key is a unique code specifying the special options associated to that Unit and applicable to that Unit only. In case of multiple Units in the same plant an individual License key must be set on every Unit to let Cascade being unlocked.

**Info** *Cascade is a Unit option and must be purchased as any other option. Don't forget to add it to your order for Factory activation.*

#### 3.2 Temporary License

A temporary License can be used if Cascade has not been ordered and the system layout requires its functionalities. To activate the time-limited License for Cascade please, let's proceed through menu *Commissioning – Software Options* page and the *Temporary Passwords* menu:

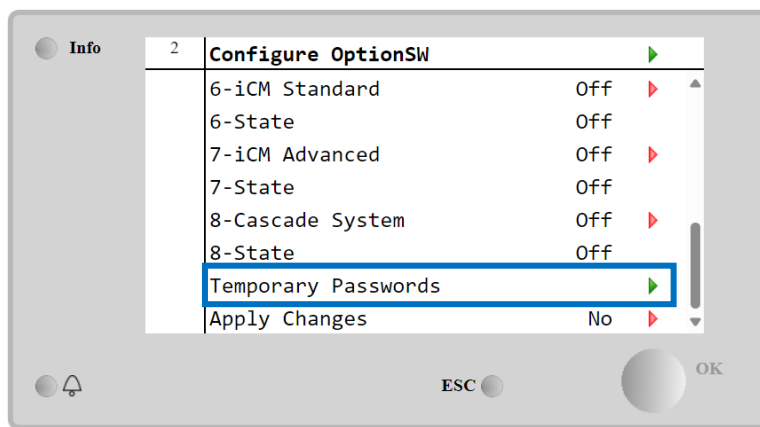

Figure 6: Temporary Activation

Then, by entering the page, three temporary passwords are displayed:

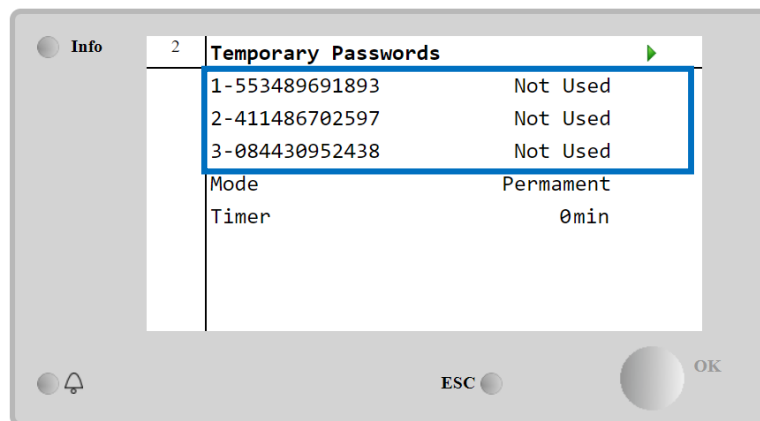

Figure 7: Temporary password activation

In the same page the usage of the activation code is also visible and a Timer indicating the remaining time before expiration can be checked.

When timer expires, Cascade option will be disabled. All the settings will be retained, and a re-activation will restart the normal sequencing as per previous configuration.

**Info** *If the Cascade get disabled because the temporary licenses expire, Daikin Applied Europe cannot be considered responsible for any consequence or claims from the customer.*

### 3.3 Permanent License

To enter a permanent License and activation key of the Cascade, go into the *Commissioning – Software Options* page:

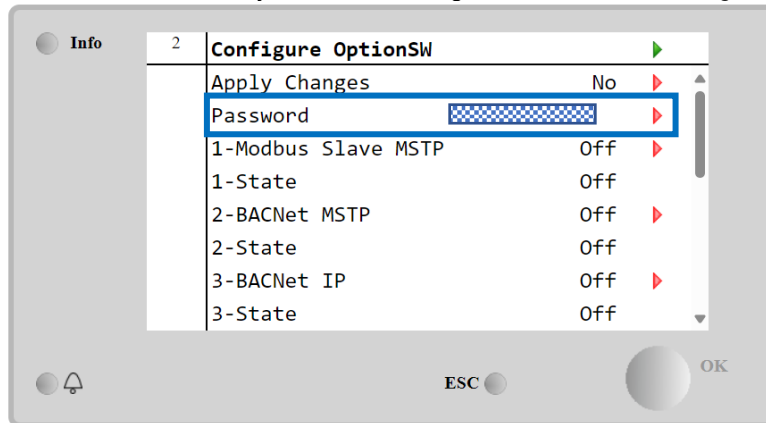

**Figure 8: Software Options page**

Click on the red arrow next to the item Password and enter the numeric License key.

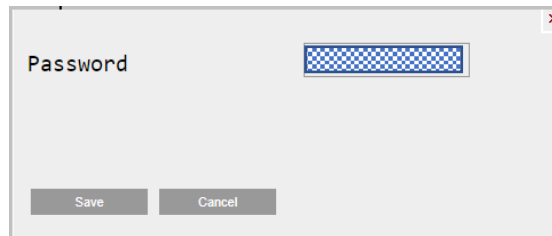

**Figure 9: Enter the license code**

With the License key correctly installed, let's proceed and activate all the options including the Cascade by changing the corresponding value to *On*, then apply all the changes.

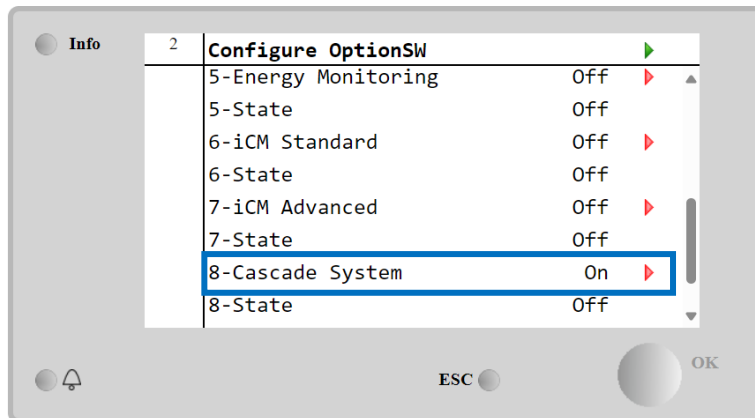

**Figure 10: Activate the iCM Standard**

After the controller reboot, go back again to the *Software Options* page and check if the activation states (8-State) are *On* to confirm the correct activation of the Cascade function.

## 4 HEATING ONLY APPLICATION

### 4.1 Plant layout

Cascade System can replace a fuel/gas boiler system in a building.

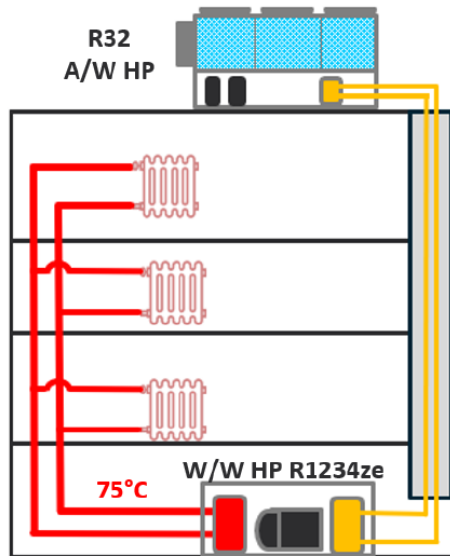

Figure 11 Only Heating plant

WCHP is used for hot water production to satisfy the DHW or HWD demand. ACHP regulates the temperature on the evaporator side of WCHP providing a stable Eewt and assuring the correct functioning of WCHP.

The recommended plant layout is the following:

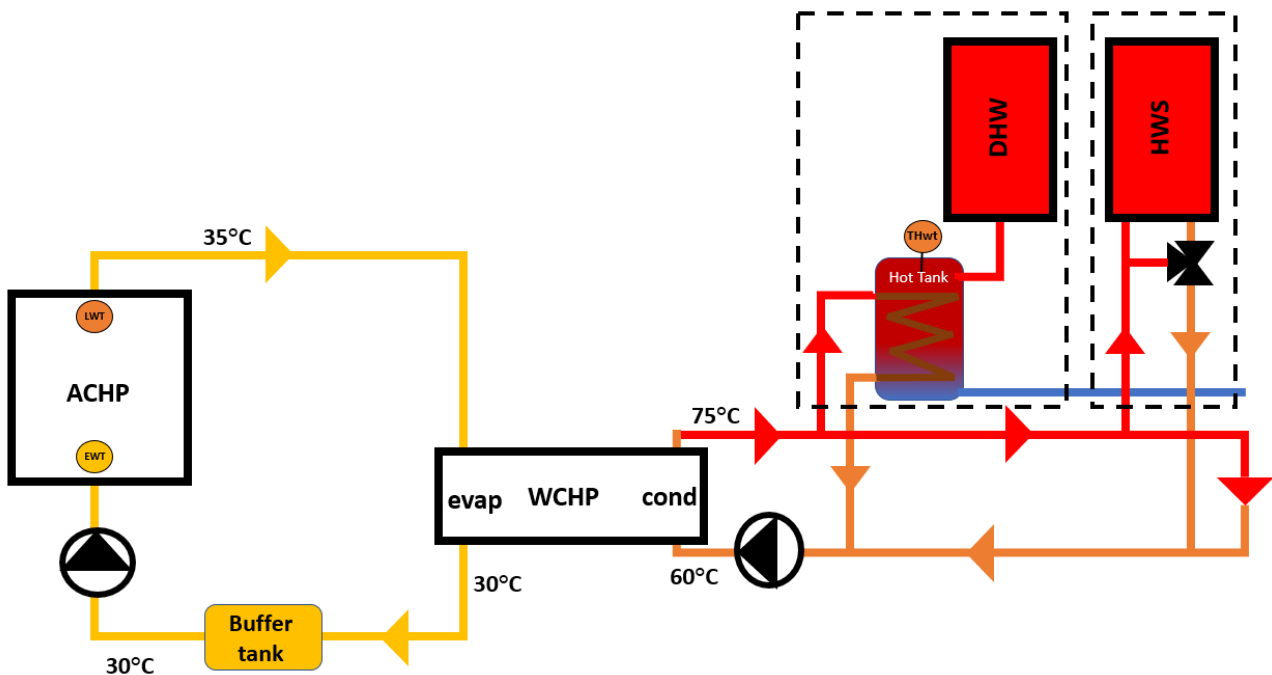

Figure 12 Cascade Configuration 1 to 1

#### NOTE:

- The Cascade Control cannot manage DHW and HWD at the same time. The above picture is an example of the pipes and peripherals connections of the two system.
- HWD is only a graphical representation; in a real plant, HWD is composed by many high temperature peripherals (radiators) with respective three-way by pass valve to regulate the room temperature.

The hardwired connection between Daikin units and peripherals on the two loops must be as follow:

- Pump on evaporator side of the WCHP is commanded by ACHP. This pump must have a Constant speed driver pump.
- Three-way bypass valve on evaporator side of WCHP, regulating the Maximum Eewt, is not necessary because ACHP keep a fixed setpoint.
- Pump on condenser side is commanded by WCHP. This pump provides hot water to Hot tank and HWD.

Moreover, in application:

- a) **For All Cascade configuration:** Hot Water temperature sensor is mandatory to evaluate the DHW or HWD demand and it must be connected to WCHP as Common Heat LWT sensor.
- b) **For HWD:** Three-way bypass valve is mandatory and it must be commanded by HWD thermoregulation (not in Cascade scope).

## 5 HMI DESCRIPTION

### 5.1 Introduction

The following sections will go into the configuration and navigation of Cascade. All the menus and submenus will be described in terms of purpose and contents. All the pages will be described in terms of parameters and settings. The two classes can be easily identified referring to the below table.

Description	Default	Range and function	AL
This is a parameter	7.6°C	-15.0°C...30.0°C This is a parameter	4
This is a setting	2	iCM: 2...8	2
This is a link to a subpage	u		4

**Table 2: Example of parameter and setting representation**

The description of any setting or parameter will also include the required Access Level (AL). Access level is defined by the password entered to access the different menus of the Microtech® 4. Please refer to the Unit's Operating Manual for more details.

Access levels are the following:

AL	Profile	Access rights
6	Basic user	Limited access to settings and parameters
4	Trained user	extended access to settings and parameters
2	Service	full access to configuration, settings and parameters

**Table 3: Access level**

Some of the settings for the lower profile users can be limited to read only but can be changeable with a higher access level.

### 5.2 Main Overview

The main overview page, in addition to containing the main data and settings of the unit, also contains the link to the Cascade menu.

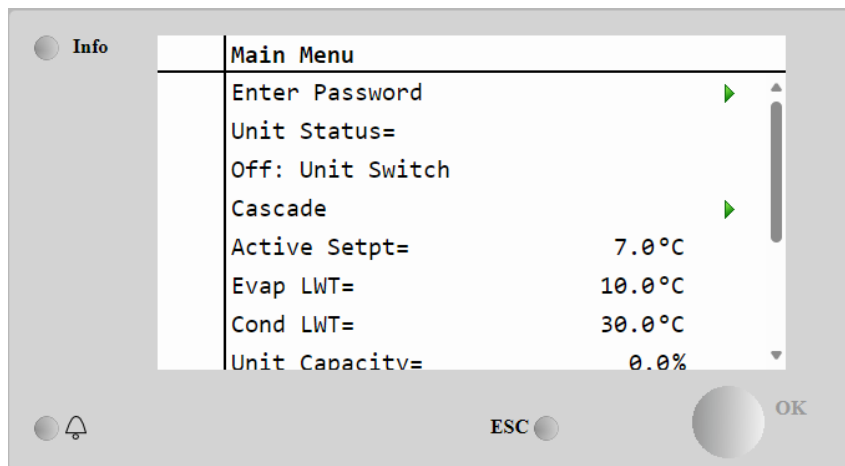

**Figure 13: Main overview page**

### 5.3 Cascade Menu

The Main Menu contains the links to all configuration and visualization pages. The following table will list all the sections and the related contents.

Description	Default	Range and function	AL
Data	▶		
A link that will show a page with additional data related to cascade			
Settings	▶		6
A link that will show a page with additional settings related to cascade			
Maintenance	▶		4

A link that will show a page with additional maintenance data related to cascade			
Configuration	▶		4
A link that will show a page with additional configuration settings related to cascade			

**Table 4: Cascade menu**

### 5.3.1 Configuration menu

This section lists the Cascade configuration parameter.

Description	Default	Range and function	AL
Address	None	None, Mst, Slv	2
This allows to set the address type			
Plant Type	OnlyDhw	OnlyDHW, Heat+DHW, C/H+DHW	2
This allows to set the plant type between "Only Domestic Hot Water", "Heat+Domestic Hot Water", "Cool/Heat Domestic Hot Water"			
Sec Loop	N/Cgf	N/Cgf, Cfgd	2
This allows to set the secondary loop. This must NOT be configured only for "only DHW" system This hardware configuration cannot be configured simultaneously on the master and the slave.			
SecRetT Type	None	None, NTC10K, PT1K	2
This allows to set the secondary returned temperature sensor type			
Apply Changes	No	No, Yes	2
This allows to reboot the controller			

**Table 5: Configuration menu**

	<b><i>These configurations to be enabled require the controller reboot.</i></b>
---	---

### 5.3.2 Data menu

This section lists the Cascade current data.

	<b><i>The follow page to be enabled requires that the controller has Address=Master in configuration menu.</i></b>
---	--

Description	Default	Range and function	AL	Plant Type
ActCmd	off	off, on		
This shows the actual command				
Setpoints	▶		6	
A link from this data will show a page with additional setpoints related to Cascade				
ActModeSp	Cool	Cool, Heat		
This shows the actual operating setpoint				
DHWActSp	-.-°C	35.0°C...80.0°C		
This shows the Domestic Hot Water actual setpoint				
DHWLwt	-.-°C			
This shows the Domestic Hot Water leaving water temperature				
DHWHoldLeft	0s			
This shows the DHW timer remaining				
EvapLWT	-.-°C			
This shows the evaporator leaving water temperature of the ACHP				
CascClearTimer	off	off, on		MixedOp
This allows to reset the cascade timers				
AirCool HP	N/Av	Off, Run, Alarm, ComEr, N/Av, N/Cfgd, wait		MixedOp



This shows the actual operating status of AirCool Heat Pump. A link from this data will show a page with additional information related to AirCool Heat Pump.			
WaterCool HP	N/Av	Off, Run, Alarm, ComEr, N/Av, N/Cfgd, wait	MixedOp
This shows the actual operating status of WaterCool Heat Pump. A link from this data will show a page with additional information related to WaterCool Heat Pump			

**Table 6: Cascade data menu**

### 5.3.2.1 Setpoints menu

This section will list the Cascade setpoint menu.

Description	Default	Range and function	AL
CtrlSource	HMI	HMI, Ntwk	4
This allows to set the control source			
CasEnSp	off	off, On	4
This allows to set the cascade enable setpoint			
DHWSp	75.0 °C	35.0 °C...80.0 °C	4
This allows to select the DWW setpoint			
EvapHeatSp	25.0 °C	20.0 °C...30.0 °C	4
This allows to select the actual evaporator heat setpoint. - Only-Heat configuration -> Heat setpoint for ACHP. - C/H+DHW configuration -> protection heat setpoint for ACHP (used after changeover in Heat for low secondary temp)			
CasEnSpNtwk	off	off, On	
This value indicates the cascade enable setpoint sent by BMS when Control Source = Network			
DHWspNtwk	-.- °C		
This value indicates the cascade DHW setpoint sent by BMS when Control Source = Network			

**Table 7: Cascade setpoint menu**

**Is possible to set the values of control functions of the Cascade.  
The values chosen depend on "Control Source" setting of Master Unit controller.**



- **If "Control Source" is Local:**  
**Setpt: Local setpoint on HMI of Master controller will be communicated to Cascade**
- **If "Control Source" is Network**  
**Setpt Ntwk: Writeable setpoint by BMS through Modbus or BACnet communication with Master Unit controller, that will be communicated to the Cascade**

### 5.3.2.2 Air-Cooled Heat Pump

This section will list the Air-Cooled Heat Pump data.

Description	Default	Range and function	AL
Status	off	Off, Run, Alarm, ComEr, N/Av, N/Cfgd, wait	
This shows the AC-HP status			
ActCmd	off	Off, On	
This shows the AC-HP actual command			
OpSta	off	Off, On	
This shows the AC-HP actual operating status			
Avail	No	No, Yes	
This shows the actual availability			
EvapPumpSta	off	Off, Start, Run	
This shows the actual evaporator pump actual operating state			
ActSp	-.- °C	-20.0 °C...80.0 °C	
This shows the actual temperature setpoint			

HeatSp	-.-°C	-8.0°C...80.0°C	
This shows the actual heat temperature setpoint			
CoolSp	-.-°C	-8.0°C...18.0°C	
This shows the actual cool temperature setpoint			
UnitMode	Cool	Cool, Ice, Heat, Test, Pursuit	
This shows the actual operating mode. Pursuit mode is not available			
ModeSp	Cool	Ice, Cool, Heat	
This shows the actual operating mode			
EvapEWT	-.-°C		
This shows the evaporator entering water temperature			
EvapLWT	-.-°C		
This shows the evaporator leaving water temperature			

**Table 8: ACHP data menu**

### 5.3.2.3 Water-Cooled Heat Pump

This section will list the Water-Cooled Heat Pump data.

Description	Default	Range and function	AL
ActCmd	Off	Off, On	
This shows the WC-HP actual command			
OpSta	Off	Off, On	
This shows the WC-HP actual operating status			
Avail	No	No, Yes	
This shows the actual availability			
EvapPumpSta	Off	Off, Start, Run	
This shows the actual evaporator pump actual operating state			
ActSp	-.-°C	-20.0°C...80.0°C	
This shows the actual temperature setpoint			
HeatSp	-.-°C	-8.0°C...80.0°C	
This shows the actual heat temperature setpoint			
CoolSp	-.-°C	-8.0°C...18.0°C	
This shows the actual cool temperature setpoint			
UnitMode	Cool	Cool, Ice, Heat, Test, Pursuit	
This shows the actual operating mode. Pursuit mode is not available			
ModeSp	Cool	Ice, Cool, Heat	
This shows the actual operating mode			
EvapEWT	-.-°C		
This shows the evaporator entering water temperature			
EvapLWT	-.-°C		
This shows the evaporator leaving water temperature			
CondEWT	-.-°C		
This shows the condenser entering water temperature			
CondLWT	-.-°C		
This shows the condenser leaving water temperature			

**Table 9: WC-HP data menu**

### 5.3.3 Settings menu

This section will list the Cascade settings menu. The following table will list all the sections and the related contents.

Description	Default	Range and function	AL
CasStartDly	2min	0min...60min	6
This shows the cascade start for temperature delay			
CasShutDly	2min	0min...60min	6
This shows the cascade shut for temperature delay			
CasCycleTime	2min	0min...60min	6
This shows the cascade cycle timer			
DHWStartDT	2.7 °Cd	0.0 °Cd...5.0 °Cd	6
This shows the DHW start up delta temperature			
DHWShutDT	0.0 °Cd		6
This shows the DHW shut down delta temperature			

**Table 10: Cascade settings menu**

### 5.3.4 Maintenance menu

This section will list the Cascade maintenance menu.

Description	Default	Range and function	AL
CmnTempOfs	0.0 °C	-5.0 °C...5.0 °C	4
This allows to select the common temperature sensor offset. - WCHP: Condenser temperature -> DHW temperature. - ACHP: Evaporator temperature -> Evaporator primary temperature			
ComErrDly	5s	0s...60s	4
This allows to select the communication error alarm delay			
DisconSp	off	off, on	4
This allows to set the disconnect setpoint. This setpoint (If DisconSp=Yes) disconnect unit from Cascade control			
EvapPmpDlyoff	10s - 10min	10s - 0min...30min	4
This allows to select the evaporator pump delay off. If the system configuration is "Only-Heat" the delay is configurable between 0min and 30min. Otherwise the delay is fixed at 10s.			
EvapHiTempDiff	1.0 °Dc	AC_ShutDT...5.0 °Dc	6
This shows the intermediate loop high temperature differential for only-heat configuration			

**Table 11: Cascade maintenance menu**

## 6 SYSTEM COMMISSIONING

This section explains how the Cascade shall be configured and set to provide proper control of the system. The purpose would be to provide a guideline that, starting from some example, can help to extend the same operations to any plant covered by Cascade system.



**Before starting to read the following, it's strongly suggested to read the HMI description to get familiarity with some terminology and choices.**

### 6.1 How to configure the Cascade

Configuration settings are divided in two different menu:

- 1) Main Menu → Commission Unit → Configuration → Software Options
- 2) Main Menu → Commission Unit → Configuration → System Control
- 3) Main Menu → Cascade → Configuration

#### 6.1.1 Software Options Menu

In Menu Software Options is possible to insert the license key to enable "Cascade" option.



**Refer to section 2 for licensing of the Cascade option (Opt. 237).**

#### 6.1.2 System Control Menu

In this menu operator can set the Daikin unit address in a Cascade plant.



**Before starting to read the following, it's strongly suggested to read section 2.4 "Cascade Architecture".**

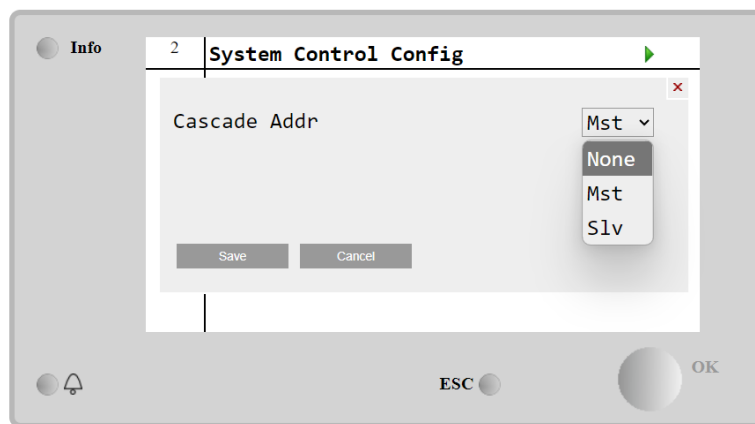

**Figure 14: Cascade address setting**

In case where the iCM option has also been activated, the M/S address must also be set.



**In case the iCM option has been activated, refer to iCM installation operating manual.**

### 6.1.3 Configuration Menu

If the unit has been configured as Master, in this menu the operator can configure the Cascade option.

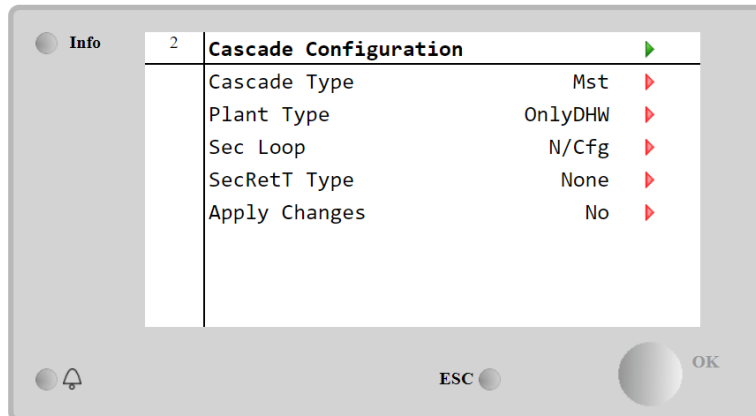

Figure 15: Cascade configuration menu

- Cascade Type allows operator to change the Cascade address (Mst / Slv)
- Plant Type allows to select the Plant Configuration Type

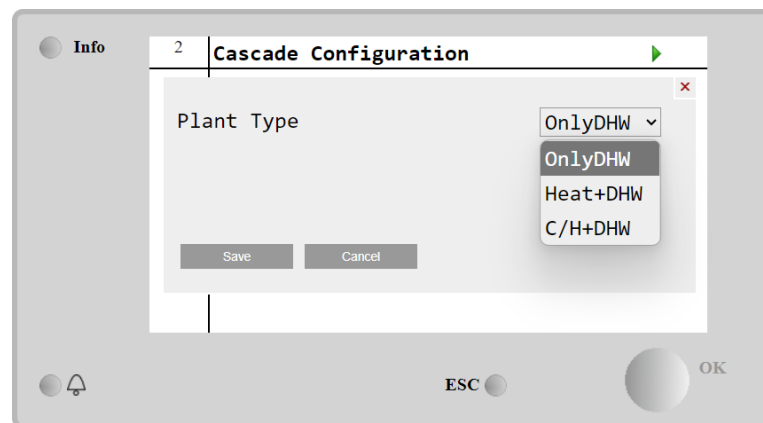

Figure 16: Plant Type setting



For this configuration refer to the section 2.3

## 6.2 How to configure Ethernet IP communication

Communication between Cascade Master and Cascade Slave is through BACnet over Ethernet IP.

For this reason, the IP network must be configured correctly. It is mandatory that the devices have a Unique address on the same IP subnet network.

### 6.2.1 IP settings for controllers

The IP network on the controllers can be configured in:

- Main Menu → View/Set Unit → Controller IP Setup → Settings
  - 1) DHCP = Passive
  - 2) Set IP Address
  - 3) Apply Changes

The IP address of the controller is the same used by BACnetIP software option (option 182)

### 6.2.2 IP settings for BACnet IP Module (only Master) (EKCBACIP)

The IP network on the BACnet IP module can be configured directly on HMI of Master.

- Main Menu → Commission Unit → 1-BACnetIP
  - 1) DHCP = Passive
  - 2) Set Given IP Address

- 3) Apply Changes
- 4) Verify that the actual IP address matches the previously configured IP address

	<p><b>IP addresses must be on the same IP subnet network.</b>  <b>For example, if the user chooses to use subnet 192.168.1.XXX, the configuration of IP Address of the devices could be as follows:</b></p> <ul style="list-style-type: none"> <li>- <b>IP Address Cascade Master: 192.168.1.42</b></li> <li>- <b>IP Address BACnet/IP Module (POL908): 192.168.1.44</b></li> <li>- <b>IP Address Cascade Slave: 192.168.1.43</b></li> </ul>
---	--

	<p><b>Incorrect configuration of the IP Addresses of devices do not guarantee proper operation of the cascade system</b></p>
---	--

## 6.3 How to configure BACnet IP for Cascade

After configuring the cascade, it is required to configure the parameters for BACnet IP communication.

### 6.3.1 BACnet IP Embedded

It is important that the BACnet Device ID and BACnet Name are configured properly in each unit.

To configure the BACnet IP parameters follow the following steps:

- Main Menu → Commission Unit → BACnet IP

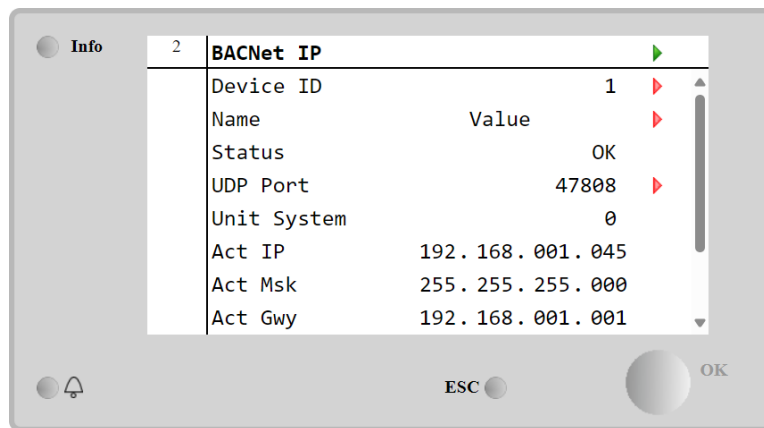

Figure 17: BACnet IP menu

In this menu the following parameters must be set:

1. *Device ID* must be set as
  - a. For ACHP: 3242
  - b. For WCHP: 3243
2. *Name* must be different between the ACHP and WCHP controllers and unique among all the device in the BACnet Network.

	<p><b>Incorrect configuration of the BACnet Device ID or Name does not guarantee proper operation of the cascade system</b></p>
---	---

### 6.3.2 BACnet IP Module (only Master)

Unit elected as Cascade Master must have BACnet/IP Module (POL908). This module must be configured.

To configure the BACnet IP module:

- Main Menu → Commission Unit → 1-BACnetIP

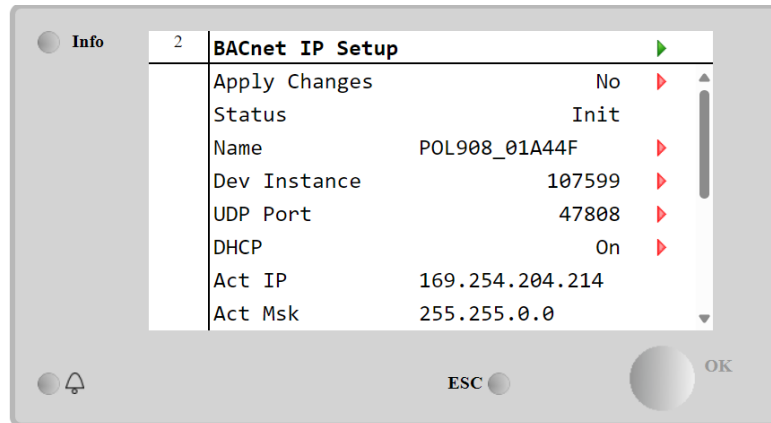

Figure 18: BACnet IP module configuration

In this menu the following parameters must be set:

1. *Device Name* must be unique among all the device in the BACnet Network: (Recommended: "Cascade")
2. *Device Instance* must be unique among all the device in the BACnet Network. (Recommended: 3232)
3. *Unit System* must be set to "Metric"
4. *Apply Changes* → Yes

### 6.4 How to setup Unit to communicate with Cascade

Each unit must be set in "network control" in order to be managed by Cascade. On Cascade Master and Cascade Slave, the following parameter must be set.:

- *View/Set Unit* → *Status/Setting* → *Control Source* = *Network*

OR

- *View/Set Unit* → *Network control* → *Control Source* = *Network*



**In Case unit is in Control Source Local, It cannot be commanded by Cascade. Cascade detect the Control Source of the unit and it sets the corresponding "Disconnected" state to Yes**

### 6.5 How to setup the Cascade

The settings page includes the setting that define how the Cascade option will control the water temperature of the system. The parameters displayed in this menu depend on which cascade configuration has been set.

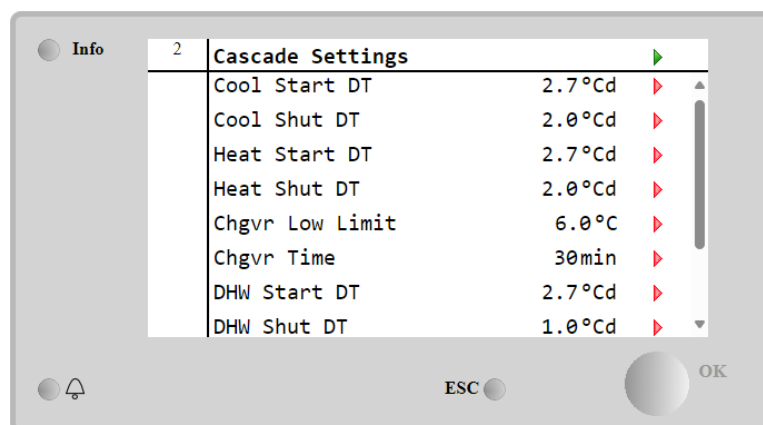
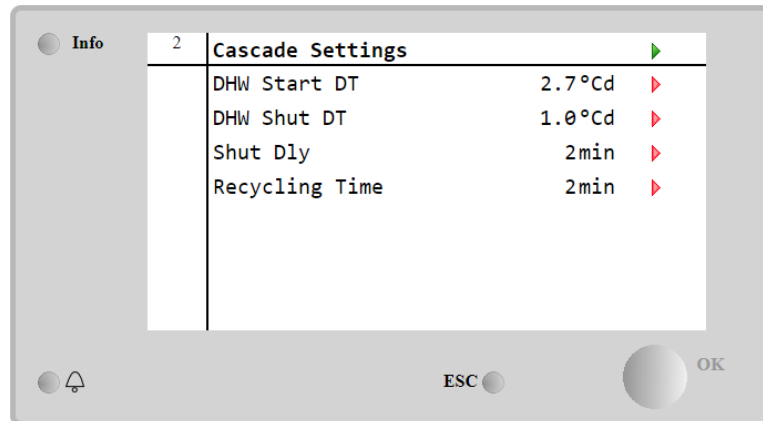

Figure 19: Settings menu in Mixed Operation configuration

### 6.5.1 Staging Temperatures Settings

For understanding there is the necessity to distinguish the two configurations:  
**Heating Only** for:



**Figure 20: DHW production settings**

In case the controlled temperature is lower than the DHW Setpoint - DHW Start DT, the logic commands the system to start and starts a WCHP unit.

Otherwise, if the controlled temperature is higher than DHW Setpoint + DHW Stop DT for a configurable time, the logic will command the system to shut down.



## 7 SYSTEM OPERATING

---

This chapter explains how to interact with controllers where Cascade is configured.

### 7.1 Cascade Enable setpoint

To enable the Cascade logic those conditions are the following:

1. Cascade Enable” = ON on unit controller HMI
2. “Network En Sp” ON unit controller HMI (only if “Control Source” = Network, i.e. Master is commanded by third party BMS though protocol communication)

If all the above conditions are true on Master Unit controller, in menu

- “Cascade → Data → Act Command” = “On”



*The number of setpoints to be set depends on the Cascade configuration done previously.*

### 7.2 System actual operating mode setpoint

Depending on the configuration made, the cascade can satisfy the heating demand or the cooling demand.

User can change the actual operating mode in:

- “Cascade → Data → Setpoint → Mode Sp”

#### 7.2.1 Mode Setpoints by Network communication

It worth noting that if Master controller is connected to a third party BMS and “Control Source = Network” on Master controller HMI, BMS can write the actual mode operating setpoint on Master; this setpoint will be the “Active setpoint” on Cascade logic.

This setpoint set by BMS can be checked on HMI:

- Cascade → Data → Setpoints → Mode Sp Ntwk

### 7.3 System water temperature setpoints

To set temperature setpoints, used by Cascade logic, user should operate on Cool, Hot and DHW setpoint on Master Unit controller.

#### 7.3.1 Cool Setpoint

User must change the Cool setpoint of the Master unit controller HMI:

- “Cascade → Data → Setpoint → Cool Sp”

#### 7.3.2 Heat Setpoint

User must change the Heat setpoint of the Master unit controller HMI:

- “Cascade → Data → Setpoint → Heat Sp”

#### 7.3.3 Domestic Hot Water Setpoint

User must change the Domestic Hot Water setpoint of the Master unit controller HMI:

- “Cascade → Data → Setpoint → DHW Sp”

#### 7.3.4 System Setpoints by Network communication

It worth noting that if Master controller is connected to a third party BMS and “Control Source = Network” on Master controller HMI, BMS can write the temperature setpoints on Master; those setpoints will become the “Active setpoints” on Master unit controller and consequently for Cascade logic.

BMS should operate on

- Cool Setpoint – Network
- Heat Setpoint – Network
- DHW Setpoint – Network

on Master Unit protocol communication (Please refer to specific Unit Protocol Communication Mapping).

The above setpoints set by BMS on Master unit controller can be checked on HMI:

- Cascade → Data → Setpoints → Cool Sp Ntwk
- Cascade → Data → Setpoints → Heat Sp Ntwk
- Cascade → Data → Setpoints → DHW Sp Ntwk

## 8 BAS INTEGRATION GUIDE

The Cascade Master can operate as a single integration point to a BMS for ACHP and WCHP units.

### 8.1 BACnet Integration Guide

Following is the Bacnet/IP points list for BMS integration.

Description	BACnet Type	BACnet Name	BACnet Instance	Range	Read/Write
Enable Setpoint Network	BV	Cas'EnSpNtwk	341	0 Off 1 On	R/W
DHW Setpoint Network	AV	Cas'DHWSpNtwk	342	°C	R/W
Heat Setpoint Network	AV	Cas'CmftHeatNtwk	343	°C	R/W
Cool Setpoint Network	AV	Cas'CmftCoolNtwk	344	°C	R/W
Comfort Operating Mode Network	MV	Cas'CmftOpModeNtwk	345	0 Null 1 Cool 2 Heat	R/W
Clear Alarm	BV	Cas'ClrAlm	346	0 Off 1 On	R/W
DHW Lwt	AI	Cas'DHWLwt	1651	°C	R
Evaporator Lwt	AI	Cas'EvapLwt	1652	°C	R
Primary Lwt	AI	Cas'PriLwt	1653	°C	R
ACHP - Actual Capacity	AV	Cas'ACHP'ActCap	1654	%	R
ACHP - Actual Command	BV	Cas'ACHP'ActCmd	1655	0 Off 1 On	R
ACHP - Communication Error	BV	Cas'ACHP'ComEr	1656	0 Off 1 On	R
ACHP - Disconnect State	BV	Cas'ACHP'DisconSta	1657	0 Off 1 On	R
ACHP - Evaporator Pump State	MV	Cas'ACHP'EvapPmpSta	1658	0 Null 1 Off 2 Start 3 Run	R
ACHP - Rapid Stop	BV	Cas'ACHP'RapStop	1659	0 Off 1 On	R
ACHP - Status	MV_red	Cas'ACHP'Status	1660	0 Null 1 Run 2 Alarm 3 ComErr 4 N/Av 5 N/Cfgd 6 WaitForLoad	R
WCHP - Actual Capacity	AV	Cas'WCHP'ActCap	1661	%	R
WCHP - Actual Command	BV	Cas'WCHP'ActCmd	1662	0 Off 1 On	R
WCHP - Communication Error	BV	Cas'WCHP'ComErr	1663	0 Off 1 On	R

Description	BACnet Type	BACnet Name	BACnet Instance	Range	Read/Write
WCHP - Condenser Pump State	MV	Cas'WCHP'CondPmpSta	1664	0 Null 1 Off 2 Start 3 Run	R
WCHP - Disconnect State	BV	Cas'WCHP'DisconSta	1665	0 Off 1 On	R
WCHP - Evaporator Pump State	MV	Cas'WCHP'EvapPmpSta	1666	0 Null 1 Off 2 Start 3 Run	R
WCHP - Rapid Stop	BV	Cas'WCHP'RapStop	1667	0 Off 1 On	R
WCHP - Status	MV_red	Cas'WCHP>Status	1668	0 Null 1 Run 2 Alarm 3 ComErr 4 N/Av 5 N/Cfgd 6 WaitForLoad	R

## 8.2 Modbus Integration Guide

Following is the MODbus points list for BMS integration.

Description	Modbus Type	Modbus Address	Modbus Gain	Range	Read/Write
Enable Setpoint Network	Unsigned Word	341	1	0 Off 1 On	R/W
DHW Setpoint Network	Signed Word	342	10	°C	R/W
Heat Setpoint Network	Signed Word	343	10	°C	R/W
Cool Setpoint Network	Signed Word	344	10	°C	R/W
Comfort Operating Mode Network	Unsigned Word	345	1	0 Null 1 Cool 2 Heat	R/W
Clear Alarm	Unsigned Word	346	1	0 Off 1 On	R/W
DHW Lwt	Signed Word	1651	10	°C	R
Evaporator Lwt	Signed Word	1652	10	°C	R
Primary Lwt	Signed Word	1653	10	°C	R
ACHP - Actual Capacity	Unsigned Word	1654	1	%	R
ACHP - Actual Command	Unsigned Word	1655	1	0 Off 1 On	R
ACHP - Communication Error	Unsigned Word	1656	1	0 Off 1 On	R
ACHP - Disconnect State	Unsigned Word	1657	1	0 Off 1 On	R

Description	Modbus Type	Modbus Address	Modbus Gain	Range	Read/Write
ACHP - Evaporator Pump State	Unsigned Word	1658	1	0 Null 1 Off 2 Start 3 Run	R
ACHP - Rapid Stop	Unsigned Word	1659	1	0 Off 1 On	R
ACHP - Status	Unsigned Word	1660	1	0 Null 1 Run 2 Alarm 3 ComErr 4 N/Av 5 N/Cfgd 6 WaitForLoad	R
WCHP - Actual Capacity	Unsigned Word	1661	1	%	R
WCHP - Actual Command	Unsigned Word	1662	1	0 Off 1 On	R
WCHP - Communication Error	Unsigned Word	1663	1	0 Off 1 On	R
WCHP - Condenser Pump State	Unsigned Word	1664	1	0 Null 1 Off 2 Start 3 Run	R
WCHP - Disconnect State	Unsigned Word	1665	1	0 Off 1 On	R
WCHP - Evaporator Pump State	Unsigned Word	1666	1	0 Null 1 Off 2 Start 3 Run	R
WCHP - Rapid Stop	Unsigned Word	1667	1	0 Off 1 On	R
WCHP - Status	Unsigned Word	1668	1	0 Null 1 Run 2 Alarm 3 ComErr 4 N/Av 5 N/Cfgd 6 WaitForLoad	R

## 9 TROUBLESHOOTING

This chapter will try to explain the alarms and events generated by the Cascade and guide to resolution. In the following sections all the alarms will be described. Alarms will disable the Cascade or will reduce their ability to control the system properly.

### 9.1 BACnet Option Alarm

This alarm on Unit controller can occur during configuration of Cascade Control and it indicates that the BACnet option (Option 184) has not been enabled.

Symptom	Cause	Solution
Bell icon is moving on controller's display. String in the alarm list: <i>BAC Config Alm</i>  System does not start.	<i>BACNET IP software option has not been activated on the controller.</i>	Commissioning → Configuration → Software Options → BACNet IP = On  It is necessary to enable the software option BACnet IP ( <i>Opt. 182</i> ) and reboot the controller.
Reset	.	Notes
Local HMI Network	<input type="checkbox"/> <input type="checkbox"/>	

### 9.2 Cascade / WHCP / ACHP Missing Alarm

This alarm can occur after configuration of Cascade Option and Cascade Master or Slave cannot find the each other on the IP Network.

Symptom	Cause	Solution
Bell icon is moving on controller's display. String in the alarm list: <i>Cas Miss Alarm</i> <i>WCHP Miss Alm</i> <i>ACHP Miss Alm</i>  System does not start.	Wrong configuration of the system.	Check IP Configuration of Unit and of BACnet module Check BACnet Option configuration parameter. Check BACnet IP Module configuration parameter Check Ethernet cable connection Check Ethernet switch functioning
Reset	.	Notes
Local HMI Network	<input type="checkbox"/> <input type="checkbox"/>	The alarm clears automatically when the communication is re-established.

### 9.3 Cascade / WCHP / ACHP Communication Error Alarm

This alarm can occur on the Unit as Slave Cascade when it is not able to communicate with Cascade Master or on Cascade Master when it cannot communicate with the water-cooled unit.

Symptom	Cause	Solution
Bell icon is moving on controller's display. String in the alarm list: <i>Cas Comm Err</i> <i>WCHP Comm Err</i> <i>ACHP Comm Err</i>  Cascade System keeps on running	Configuration from Cascade has not been received through Daikin Network.	Check that Ethernet cable is correctly connected Check that Ethernet switch is functioning
Reset	.	Notes
Local HMI Network	<input type="checkbox"/> <input type="checkbox"/>	The alarm clears automatically when the communication is re-established.

## 9.4 Domestic Hot Water Temperature Alarm

This alarm on Master Cascade unit indicates that the sensor for domestic hot water temperature is not working properly.

Symptom	Cause	Solution
Bell icon is moving on controller's display. String in the alarm list: <i>DHW Sens Alm</i>  Replace with Condenser Leaving water temperature of WCHP	Sensor is broken.	Check for sensor integrity. according to table and allowed kOhm (kΩ) range.  Check correct sensors operation
	Sensor is shorted	Check if sensor is shorted with a resistance measurement.
	Sensor is not properly connected (open).	Check for absence of water or humidity on electrical contacts.
		Check for correct plug-in of the electrical connectors.  Check for correct sensors wiring also according to electrical scheme.
Reset		Notes
Local HMI Network	<input type="checkbox"/> <input type="checkbox"/>	

## 9.5 Evaporator Leaving Water Temperature Alarm

This alarm on ACHP unit indicates that the sensor for Common evaporator leaving water temperature is not working properly.

Symptom	Cause	Solution
Bell icon is moving on controller's display. String in the alarm list: <i>vap LWT Alm</i>  Forced Stop of ACHP and whole system.	Sensor is broken.	Check for sensor integrity. according to table and allowed kOhm (kΩ) range.  Check correct sensors operation
	Sensor is shorted	Check if sensor is shorted with a resistance measurement.
	Sensor is not properly connected (open).	Check for absence of water or humidity on electrical contacts.
		Check for correct plug-in of the electrical connectors.  Check for correct sensors wiring also according to electrical scheme.
Reset		Notes
Local HMI Network	<input type="checkbox"/> <input type="checkbox"/>	

*The present publication is drawn up only for technical support and it does not constitute a binding commitment for Daikin Applied Europe S.p.A.. Its content has been written by Daikin Applied Europe S.p.A. to the best of its knowledge. No explicit or implied warranty is given for the completeness, accuracy, reliability of its contents. All data and specifications contained therein may be subject to change without notice. Refer to the data communicated at the time of the order. Daikin Applied Europe S.p.A. explicitly rejects any liability for any direct or indirect damage, in the broadest sense, arising from or related to the use and/or interpretation of this publication. All content is copyrighted by Daikin Applied Europe S.p.A..*

**DAIKIN APPLIED EUROPE S.p.A.**

Via Piani di Santa Maria, 72 - 00072 Ariccia (Roma) - Italy

Tel: (+39) 06 93 73 11 - Fax: (+39) 06 93 74 014

<http://www.daikinapplied.eu>