

# ADDENDUM BOOK FOR OPTIONAL EQUIPMENT OF THE HEAT PUMP MODULE

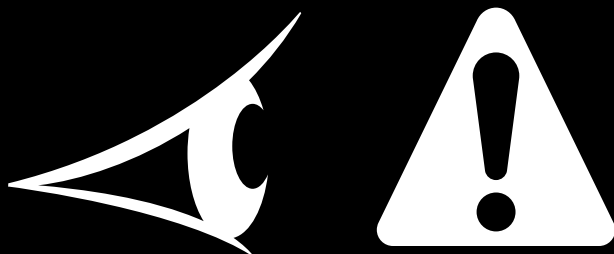

Unit + digital I/O PCB  
Unit + demand PCB  
Unit + solar kit  
Unit + wired room thermostat  
Unit + wireless room thermostat  
Unit + heat pump convector  
Unit + domestic hot water tank  
Unit + remote indoor sensor

- (GB) Before obtaining access to terminals, all power supply circuits must be interrupted.**  
IMPROPER INSTALLATION OR ATTACHMENT OF EQUIPMENT OR ACCESSORIES COULD RESULT IN ELECTRIC SHOCK, SHORT-CIRCUIT, LEAKS, FIRE OR OTHER DAMAGE TO THE EQUIPMENT. BE SURE ONLY TO USE ACCESSORIES MADE BY DAIKIN/ROTEX WHICH ARE SPECIFICALLY DESIGNED FOR USE WITH THE EQUIPMENT AND HAVE THEM INSTALLED BY A PROFESSIONAL.  
IF UNSURE OF INSTALLATION PROCEDURES OR USE, ALWAYS CONTACT YOUR DAIKIN/ROTEX DEALER FOR ADVICE AND INFORMATION.
- (D) Vor Zugriff auf die klemmen müssen die Stromkreise der Spannungsversorgung unterbrochen werden.**  
UNSACHGEMASSE INSTALLATION ODER BEFESTIGUNG DER AUSRÜSTUNG ODER DER ZUBEHÖRTEILE KANN ZU ELEKTRISCHEM SCHLAG, KURZSCHLUSS, AUSLAUFEN VON FLÜSSIGKEIT, BRAND ODER ANDEREN SCHADEN DER AUSRÜSTUNG FÜHREN. VERWENDEN SIE NUR ZUBEHÖRTEILE VON DAIKIN/ROTEX, DIE SPEZIELL FÜR DEN EINSATZ MIT DER AUSRÜSTUNG ENTWICKELT WURDEN, UND LASSEN SIE SIE VON EINEM FACHMANN INSTALLIEREN.  
SOLLTEN FRAGEN ZUM INSTALLATIONSVERFAHREN ODER ZUM EINSATZ AUFTRETEN, WENDEN SIE SICH BITTE AN IHREN DAIKIN/ROTEX-HANDLER. VON IHM ERHALTEN SIE DIE NOTWENDIGEN RATSCHLAGE UND INFORMATIONEN.
- (F) Avant d'accéder aux moyens de raccordement, tous les circuits d'alimentation doivent être déconnectés.**  
UNE INSTALLATION OU FIXATION INCORRECTE DE L'EQUIPEMENT OU DES ACCESSOIRES PEUT PROVOQUER UNE ELECTROCUTION, UN COURT-CIRCUIT, DES FUITES, UN INCENDIE OU AUTRE DOMMAGE DE L'EQUIPEMENT. S'ASSURER DE N'UTILISER QUE DES ACCESSOIRES FABRIQUES PAR DAIKIN/ROTEX SPECIALEMENT CONÇUS POUR ETRE UTILISES AVEC CET EQUIPEMENT ET LES FAIRE INSTALLER PAR UN PROFESSIONNEL.  
EN CAS DE DOUTE QUANT AUX PROCEDURES D'INSTALLATION OU D'UTILISATION, PRENDRE TOUJOURS CONTACT AVEC VOTRE CONCESSIONNAIRE DAIKIN/ROTEX POUR TOUT CONSEIL ET INFORMATION.
- (NL) Voordat u de klemmen behandelt dienen alle spanningscircuits afgesloten te worden.**  
EEN FOUTE INSTALLATIE OF BEVESTIGING VAN APPARATUUR OF TOEBEHOREN KAN EEN ELEKTRISCHE SCHOK, KORTSLUITING, LEKKEN, BRAND, OF ANDERE SCHADE AAN DE APPARATUUR VEROORZAKEN. GEBRUIK DAAROM UITSLUITEND DAIKIN/ROTEX TOEBEHOREN DIE SPECIAAL ONTWERPEN ZIJN VOOR TOEPASSING MET DE APPARATUUR EN LAAT ZE OOK INSTALLEREN DOOR EEN VAKMAN.  
RAADPLEEG BIJ TWIJFELS OVER DE INSTALLATIEPROCEDURES OF HET GEBRUIK ALTIJD UW DAIKIN/ROTEX VERDELER VOOR ADVIES EN INFORMATIE.
- (E) Antes de acceder a los terminales se deben cortar todos los circuitos de alimentación eléctrica.**  
LA INSTALACIÓN O COLOCACIÓN INADECUADA DEL EQUIPO O ACCESORIOS PODRÍA PRODUCIR DESCARGAS ELÉCTRICAS, CORTOCIRCUITOS, FUGAS U OTROS DAÑOS AL EQUIPO. ASEGÚRESE DE UTILIZAR SÓLO ACCESORIOS FABRICADOS POR DAIKIN/ROTEX QUE ESTÉN ESPECIALMENTE DISEÑADOS PARA SU USO CON EL EQUIPO Y HAGA QUE LO INSTALE UN PROFESIONAL.  
SI NO ESTÁ SEGURO DE LOS PROCEDIMIENTOS DE INSTALACIÓN O DE USO, PÓNGASE SIEMPRE EN CONTACTO CON EL DISTRIBUIDOR DE DAIKIN/ROTEX PARA PEDIR ASESORAMIENTO E INFORMACIÓN.
- (I) Prima di accedere ai terminali, occorre interrompere l'alimentazione di tutti i circuiti dell'unità.**  
L'INSTALLAZIONE O IL MONTAGGIO IMPROPRI DELL' APPARECCHIO O DI UN SUO ACCESSORIO POTREBBERO DAR LUOGO A FOLGORAZIONI, CORTOCIRCUITI, PERDITE, OPPURE DANNI ALLE TUBAZIONI O AD ALTRE PARTI DELL' APPARECCHIO STESSO. USARE ESCLUSIVAMENTE ACCESSORI ORIGINALI DAIKIN/ROTEX, CHE SONO SPECIFICAMENTE PROGETTATI PER ESSERE USATI SU APPARECCHI DI QUESTO TIPO PRETENDENDO CHE ESSI VENGANO MONTATI ESCLUSIVAMENTE DA UN INSTALLATORE QUALIFICATO.  
CONTATTARE L'INSTALLATORE DAIKIN/ROTEX CHE HA MONTATO GLI APPARECCHI PER AVERE DEI CONSIGLI IN CASO SI ABBIANO DEI DUBBI A RIGUARDO LE PROCEDURE DI MONTAGGIO O LE PROCEDURE D'USO.

- ⓐ Addendum book for optional equipment**
- ⓓ Ergänzendes Buch für optionale Ausstattungen**
- ⓕ Ouvrage complémentaire pour l'équipement en option**
- Ⓝ Addendum boek voor optionele apparatuur**
- ⓔ Anexo para equipo opcional**
- ⓖ Manuale di supplemento per le apparecchiature opzionali**

---

Unit + digital I/O PCB	*HYHBH/X* + EKRP1HBAA.....	2
Unit + demand PCB	*HYHBH/X* + EKRP1AHTA.....	3
Unit + solar kit	*HYHBH/X* + EKSRPS3.....	4
Unit + wired room thermostat	*HYHBH/X* + *KRTWA.....	5
Unit + wireless room thermostat	*HYHBH/X* + *KRTR1 + *KRTETS.....	5
Unit + heat pump convector	*HYHBH/X* + *FWXV15/20AVEB.....	5
Unit + domestic hot water tank	*HYHBH/X* + *KHWP300* + EKEPHT3H.....	6
Unit + domestic hot water tank	*HYHBH* + *KHWP500* + EKEPHT5H.....	6
Unit + remote indoor sensor	*HYHBH/X* + KRCS01-1.....	7

---

# \*HYHBH/X\* + EKR1HBAA

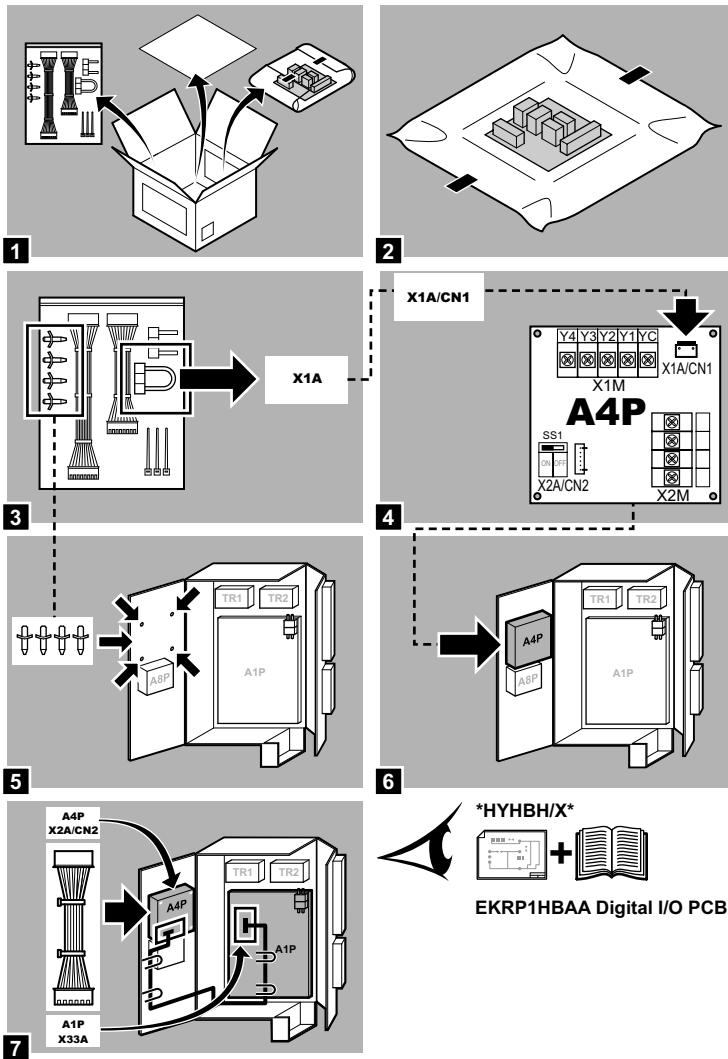

# \*HYHBH/X\* + EKRP1AHTA

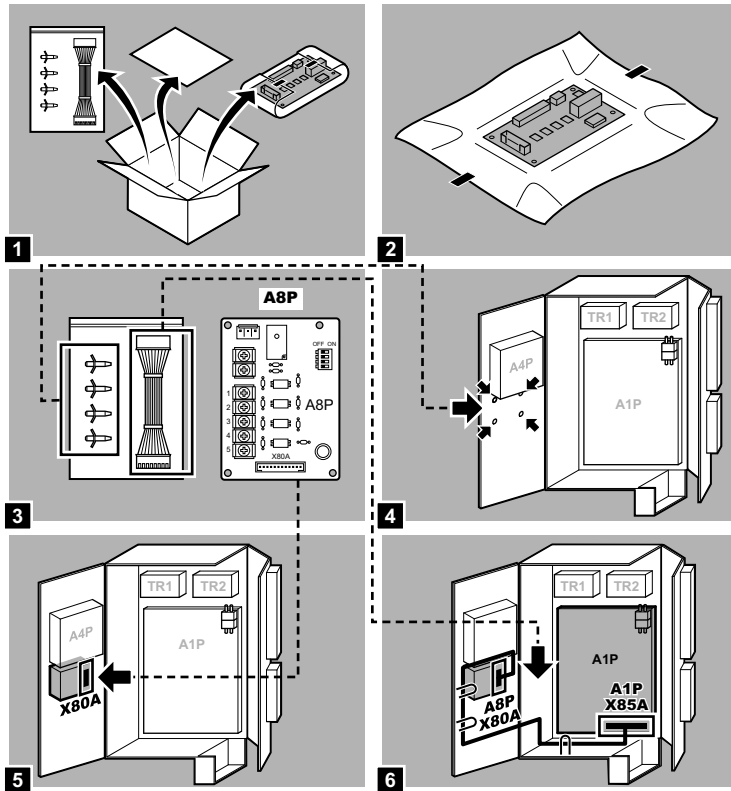

# \*HYHBH/X\* + EKSRPS3

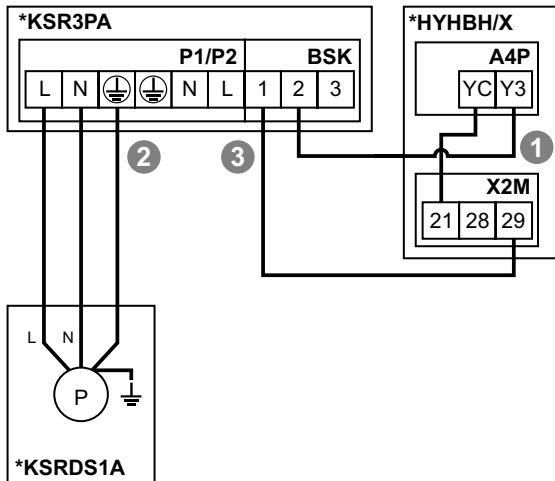
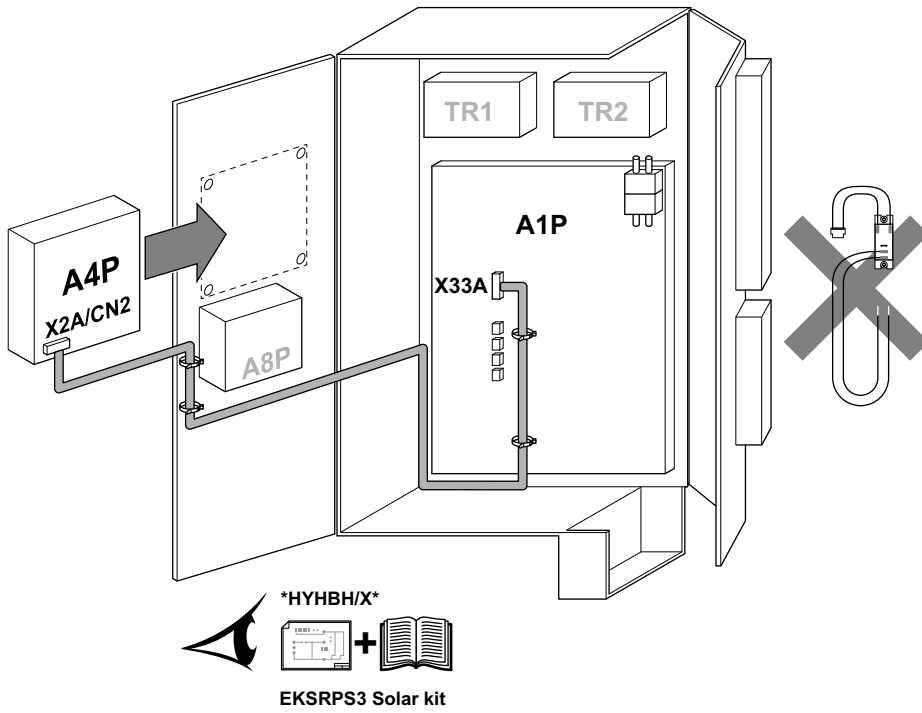

# \*HYHBH/X\* + \*KRTWA

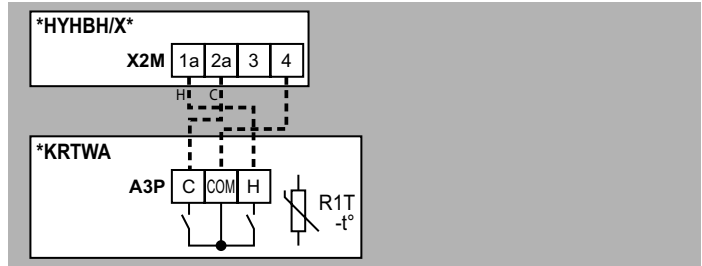
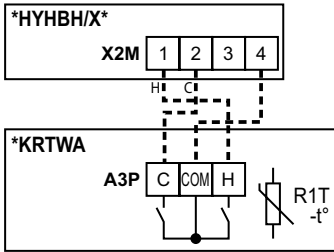

# \*HYHBH/X\* + \*KRTR1 + \*KRTETS

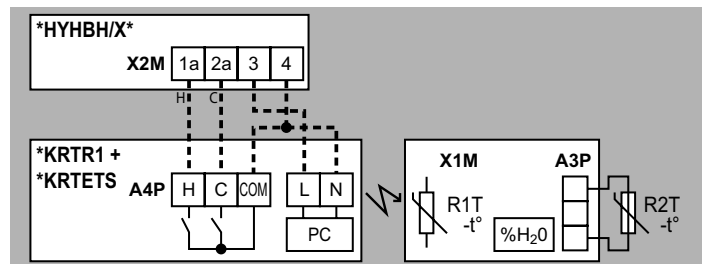
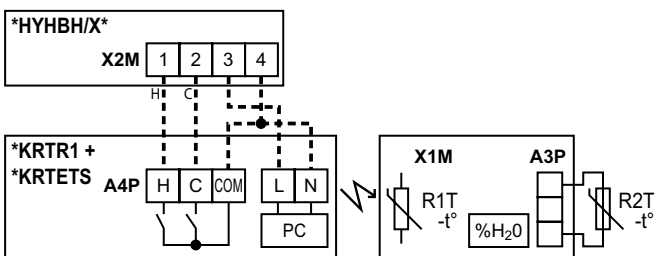

# \*HYHBH/X\* + \*FWXV15/20AVEB

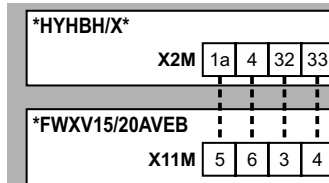
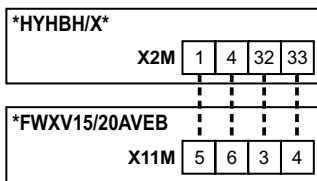

- (GB) Main leaving water temperature zone
- (D) Haupt-Vorlaufemperatur-Zone
- (F) Zone de température de départ principale
- (NL) Hoofdzone aanvoertemperatuur
- (E) Zona de temperatura de agua de impulsión principal
- (I) Zona della temperatura manuale principale

- Additional leaving water temperature zone
- Zusätzliche Vorlaufemperatur-Zone
- Zone de température de départ secondaire
- Additionele zone aanvoertemperatuur
- Zona de temperatura de agua de impulsión adicional
- Zona della temperatura manuale aggiuntiva

# \*HYHBH/X\* + \*KHWP300\* + EKEPHT3H

# \*HYHBH\* + \*KHWP500\* + EKEPHT5H

**SPST**

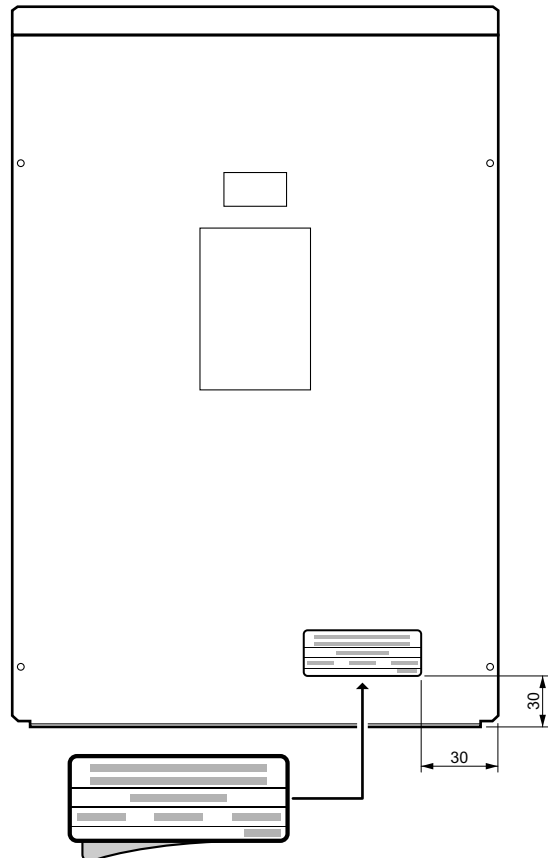
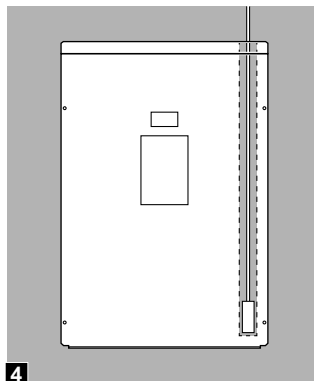
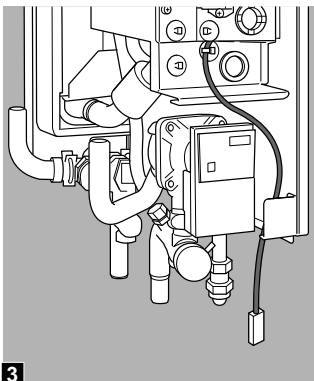
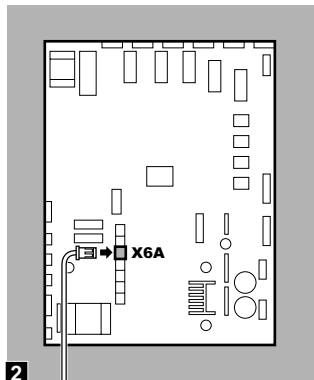
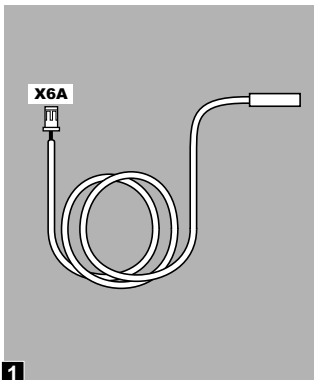
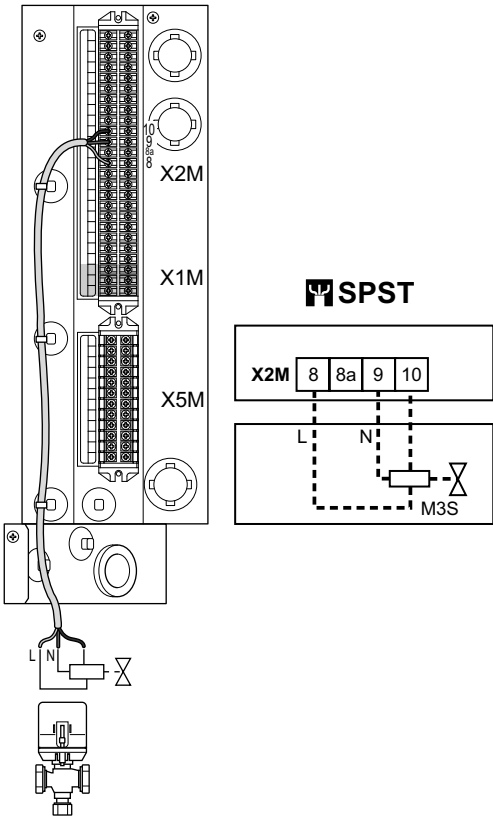

# \*HYHBH/X\* + KRCS01-1

